



RS-232 / USB Conversion adaptor

USER'S MANUAL

Manual Number	JY997D23401J
Date	Jan. 2012

This manual describes the part names, external dimensions and specifications of the product. Before use, read this manual and manuals of relevant products fully to acquire proficiency in handling and operating the product. Make sure to learn all the product information, safety information, and precautions. And, store this manual in a safe place so that you can take it out and read it whenever necessary. Always forward it to the end user. Registration The company name and the product name to be described in this manual are the registered trademarks or trademarks of each company.

Effective Jan. 2012
Specifications are subject to change without notice.
© 2008 Mitsubishi Electric Corporation

Safety Precaution (Read these precautions before using.)

This manual classify the safety precautions into two categories:

⚠ DANGER and **⚠ CAUTION**.

⚠ DANGER	Indicates that incorrect handling may cause hazardous conditions, resulting in death or severe injury.
⚠ CAUTION	Indicates that incorrect handling may cause hazardous conditions, resulting in medium or slight personal injury or physical damage.

Depending on circumstances, procedures indicated by **⚠ CAUTION** may also be linked to serious results. In any case, it is important to follow the directions for usage.

CAUTION

MOUNTING PRECAUTIONS

- Use the conversion adaptor in the environment that satisfies the general specifications described in GT10 User's Manual. Never use the product in areas with excessive dust, oily smoke, conductive dusts, corrosive gas (salt air, Cl₂, H₂S, SO₂ or NO₂), flammable gas, vibration or impacts, or exposed to high temperature, condensation, or rain and wind. Not doing so can cause an electric shock, fire, malfunction or product damage or deterioration.

CAUTION

STARTUP/MAINTENANCE PRECAUTIONS

- Do not disassemble or modify the conversion adaptor. Doing so can cause a failure, malfunction, injury or fire.
- Do not touch the conductive and electronic parts of the conversion adaptor directly. Doing so can cause a unit malfunction or failure.
- When unplugging the conversion adaptor connected to the unit, do not hold and pull the cable portion. Doing so can cause the unit or cable to be damaged or can cause a malfunction due to a cable connection fault.

CAUTION

DISPOSAL PRECAUTIONS

- When disposing of the product, handle it as industrial waste.

CAUTION

TRANSPORTATION PRECAUTIONS

- Make sure to transport the conversion adaptor and/or relevant unit(s) in the manner they will not be exposed to the impact exceeding the impact resistance described in the general specifications of this manual, as they are precision devices. Failure to do so may cause the unit to fail. Check if the unit operates correctly after transportation.

Related Manuals

When using the conversion adaptor, prepare the following manual as well. As GT10 User's Manual, GT Designer2 Version2 Basic Operation/Data Transfer Manual and GT Designer3 Version1 Screen Design Manual are sold separately, inquire at our local distributor for it. For details of a PLC to be connected, refer to the PLC user's manual respectively.

Manual name	Manual Number (Model Code)	Contents
GT10 User's Manual	JY997D24701 (09R819)	Describes the GT10 hardware-relevant content such as part names, external dimensions, mounting, wiring, specifications, and introduction to option devices.
GT Designer2 Version2 Basic Operation/Data Transfer Manual	SH-080529ENG (1D7M24)	Describes methods of the GT Designer2 installation operation, basic operation for drawing and transmitting data to GOT1000 series
GT Designer3 Version1 Screen Design Manual (Fundamentals)	SH-080866ENG (1D7MB9)	Describes methods of the GT Designer3 installation operation, basic operation for drawing and transmitting data to GOT1000 series

ⓘ: Indispensable manual

For the manuals relevant to GOT1000, refer to the PDF manuals stored in the screen creation software used. For details about a PLC to be connected, refer to the manuals of PLCs respectively. For the FA transparent functionality, refer to the GOT1000 Series Connection Manual.

Bundled Items

Product	GT10-R2TUSB-5S RS-232/USB conversion adaptor
Included items	USB driver software (CD-ROM)*1 RS-232/USB Conversion adaptor USER'S MANUAL (this manual)

*1 Download of USB driver software is possible from the following home page. MELFANSweb home page: <http://wwwf2.mitsubishielectric.co.jp/melfansweb/english/index.html>

1. Overview

The conversion adaptor convert the GOT's RS-232 interface to USB, thereby enabling the transparent functionality to transfer and monitor the sequence program, and the project data transfer between the GT10 main unit and the PC. Use this conversion adaptor with the GT09-C30USB-5P type USB cable.

2. Part Names and External Dimensions

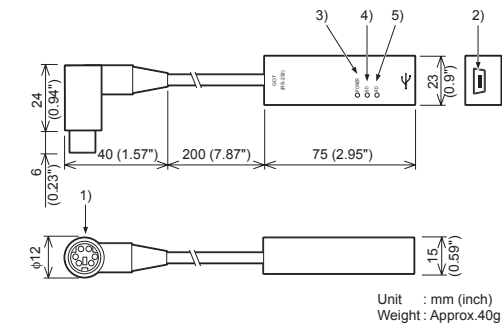

No.	Name	Specifications
1)	RS-232 Connector	MINI-DIN 6 Pins (male): For connecting GOT
2)	USB Connector	Mini-B: For connecting USB cable
3)	Display LED (POWER)	Green: Lit when the power is properly supplied (Lit when connected to the PC with a USB cable)
4)	Display LED (SD)	Red: Lit while sending data (GOT → PC)
5)	Display LED (RD)	Red: Lit while receiving data (PC → GOT)

3. Specifications

3.1 Operating atmosphere

Must be free of lamp black, corrosive gas, flammable gas, or excessive amount of electro conductive dust particles and must be no direct sunlight. (Same as for saving)

3.2 General Specifications

General specifications are the same as the GT10 main unit. For general specifications, refer to the GT10 user's manual.

3.3 Performance Specifications

Level Conversion		Bidirectional between RS-232 and USB
Communication Type	GOT	RS-232
	PC	USB2.0 (For full speed)
Transmission speed		115,200/ 57,600/ 38,400/ 19,200/ 9,600/ 4,800 bps
Supply voltage	RS-232 side	DC5V ± 5% (from GOT)
	USB side	DC5V ± 5% (from PC)
Power consumption	RS-232 side	200mW (40mA/DC5V)
	USB side	275mW (55mA/DC5V)

3.4 System Requirements (Communication driver)

OS	Microsoft® Windows®98, Windows®98SE Microsoft® Windows®Millennium Edition (Windows® Me) Microsoft® Windows®2000, Microsoft® Windows®XP Microsoft® Windows Vista®, Microsoft® Windows®7
Software	GT Designer2, GT Designer3, GX Developer, GX Works2 Refer to the following for other available software: GOT1000 Series Connection Manual (FA transparent function)

3.5 USB cable (sold separately)

Product name	Model name	
USB cable	GT09-C30USB-5P (3m)	Mitsubishi Electric System Service Co, LTD

4. System Configuration

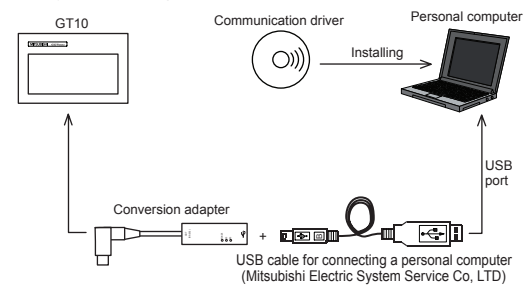

5. Connecting Procedure

- Turn the GOT power off.
- Connect the RS-232 connector of the conversion adaptor to the GOT.
- Connect the USB MINI-B connector of the USB cable to the conversion adaptor.
- Connect the USB A connector of the USB cable to the personal computer.
- Turn the GOT power on.
- Make sure the display LED (POWER) lamp of the conversion adaptor is lit. (The display LED (POWER) lamp of conversion adaptor lights when power is supplied normally by the personal computer.)

6. Driver Installation

Note: If installation of the driver software is cancelled in the middle, the driver software is not installed normally. Install the driver software again. This product requires installation of the driver software for each connected USB port. When connecting this product to multiple USB ports, install the driver software for each USB port.

Folder structure of USB driver software

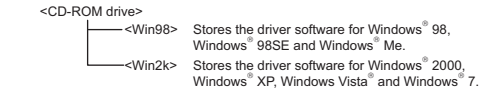

6.1 Windows® 98, Windows® 98SE, Windows® Me, Windows® 2000, and Windows® XP

Please install the driver with the following procedure.

- When the USB cable is connected to the personal computer, the following screen is displayed. (Installation of the software for USB driver)

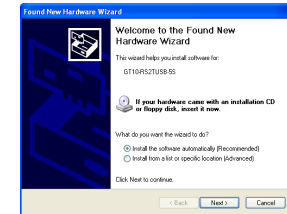

Insert the included CD-ROM into the personal computer's CD-ROM drive.

Click [Next >].

The installation of the USB driver software will begin. The installation location selection screen is displayed.

- In Windows® 98, Windows® 98SE or Windows® Me, check [Include this location in the search], specify the CD-ROM drive [Win98], and then install the driver software.
- In Windows® 2000 or Windows® XP, check [Include this location in the search], specify the CD-ROM drive [Win2K], and then install the driver software.

- The following screen is displayed. (Only in Windows® XP)



Click [Continue Anyway].

- The wizard finish screen is displayed.

Click [Finish].

If using Windows® 2000 or Windows® XP, proceed to step 4).

- In Windows® 98, Windows® 98SE or Windows® Me is used, installation of the USB Serial Port software begins, and ends automatically. The CD-ROM can be removed from the personal computer at this time. The installation of the USB driver software is finished.

- The following screen is displayed.

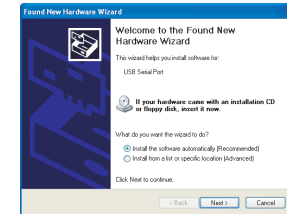

Click [Next >].

The installation of the USB Serial Port software will begin.

- In Windows® 2000, check [Include this location in the search], specify the CD-ROM drive [Win2K], and then install the driver software.
- The screen of step 2) is displayed. (Only in Windows® XP) Click [Continue Anyway].
 - The wizard finish screen is displayed. The following screen is displayed. Click [Finish]. The installation of the USB Serial Port software will finish. The CD-ROM (USB driver software) can be removed from the personal computer at this time.

6.2 Windows Vista®

Please install the driver with the following procedure.
Insert the CD-ROM offered as an accessory in the step 3).
Do not insert it earlier.

- 1) When the USB cable is connected to the personal computer, the following screen is displayed. (Installation of the software for USB driver)

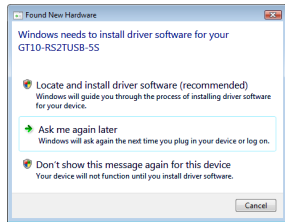

Click [Locate and install software (recommended)].

- 2) The search method confirmation screen is displayed.
Click [Don't search online].
- 3) When the message [Insert the disc that came with your GT10-RS2TUSB-5S] is displayed, insert the CD-ROM into the personal computer.
Inserting the CD-ROM starts installation.
When specifying the search location manually, specify the CD-ROM drive [Win2K].
- 4) The following warning message is displayed.

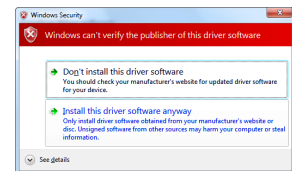

Click [Install this driver software anyway].

- 5) Installation of the driver software is started.
- 6) When installation of the USB driver software is finished, the COM port driver software is installed continuously.
The following screen is displayed.

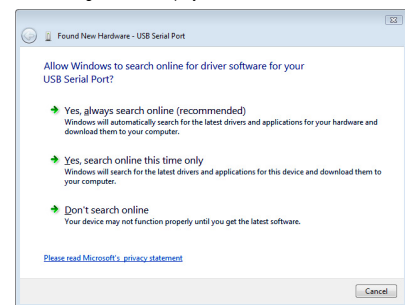

Click [Don't search online].

- 7) When the message [Insert the disc that came with your USB Serial port] is displayed, insert the CD-ROM into the personal computer.
Inserting the CD-ROM starts installation.
When specifying the search location manually, specify the CD-ROM drive [Win2K].
- 8) The following warning message is displayed.

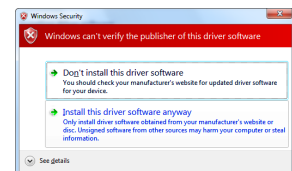

Click [Install this driver software anyway].

- 9) Installation of the driver software is started.
- 10) When installation is finished, remove the CD-ROM.
Now, installation of the USB driver software is finished.

6.3 Windows® 7 (32bits, 64bits)

Please install the driver with the following procedure.
Insert the CD-ROM offered as an accessory in the step 4).
Do not insert it earlier.

- 1) Connect the USB cable to the personal computer.
- 2) In the case of 32 bits, click [Control Panel] → [Hardware and Sound] → [Device Manager] to display the following screen.

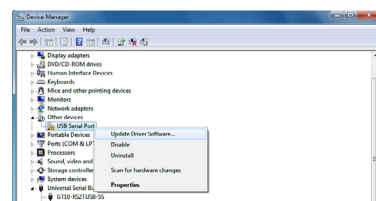

Right-click the GT10-RS2TUSB-5S, and select [Update Driver Software].
In the case of 64 bits, click [Control Panel] → [Hardware and Sound] → [Devices and Printers] to display the screen.

Right-click "GT10-RS2TUSB-5S", and select [Properties] → [Hardware] tab → [Properties] → [Change settings] → [Update Driver].

- 3) When the driver software search method selection screen is displayed, select [Browse my computer for driver software].
- 4) Insert the CD-ROM into the personal computer.
- 5) The search location specification screen is displayed.
Specify the CD-ROM drive [Win2K] as the search location, and click [Next].
Installation is started.
- 6) The following warning message is displayed.

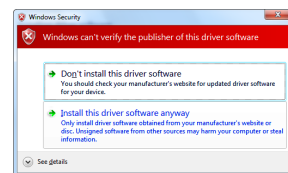

Select [Insert this driver software anyway].

- 7) Installation of the driver software is started.
- 8) When installation of the USB driver software is finished, the COM port driver software is installed continuously.

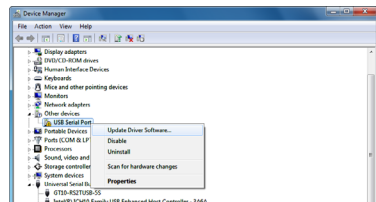

In the case of 32 bits, right-click [USB Serial Port] in the Device Manager.
Select [Update Driver Software].

In the case of 64 bits, right-click "GT10-RS2TUSB-5S" in the Devices and Printers, and select [Properties] → [Hardware] tab → [USB Serial Port] → [Properties] → [Change settings] → [Update Driver].

- 9) When the driver software search method selection screen is displayed, select [Browse my computer for driver software].
- 10) The search location specification screen is displayed.
Specify the CD-ROM drive [Win2K] as the search location, and click [Next].
Installation is started.
- 11) The following warning message is displayed.

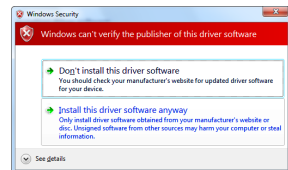

Select [Install this driver software anyway].

- 12) Installation of the driver software is started.
- 13) When installation is finished, remove the CD-ROM.
Now, installation of the USB driver software is finished.

7. Installation Confirmation of Driver, Setting Software

7.1 Installation Confirmation of Driver

Procedure for confirming the installation of the driver is described below.
Windows® XP example follows.

- In Windows® XP, click [Start] → [Settings] → [Control Panel] → [Performance and Maintenance] → [System] → [Hardware] → [Device Manager (D)] and the window below will be displayed.
Please confirm the COM number to which the USB driver is allocated (COM and LPT).
- If using Windows® 98, Windows® 98SE, Windows® Millennium Edition or Windows® 2000
A screen that is equivalent to the one below is displayed by clicking [My Computer] → [Control Panel] → [System] → [Device Manager] in the menu of the personal computer.
- In Windows Vista®, click [Start] → [Control Panel] → [Hardware and Sound] → [Device Manager] and the window below will be displayed.
- In Windows® 7, click [Control Panel] → [Hardware and Sound] → [Device Manager] and the window below will be displayed.

When the user account control is valid

Only when the user account control is valid, the [user account control] screen is displayed.
If this screen is displayed, click [Continue].

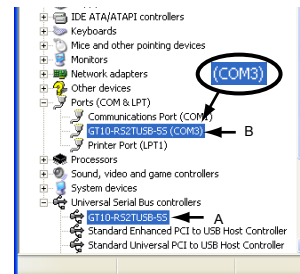

Check following:

- GT10-RS2TUSB-5S is indicated at A).
- GT10-RS2TUSB-5S (COM *) is indicated at B).
- * indicates the COM number used in Conversion adapter.
- Install the driver again when ! is displayed.

Select the programming software COM number as the COM number currently assigned on the screen above.

7.2 Setting Software

7.2.1 Setting drawing software

In GT Designer2, click [Communication] → [To/From GOT...] → [Communication configuration] tab → [RS232].
In GT Designer3, click [Communication] → [Communication Configuration...] → [RS232].

When the communication port selection screen is displayed, select the same COM number as the COM number of the personal computer. Click [OK].

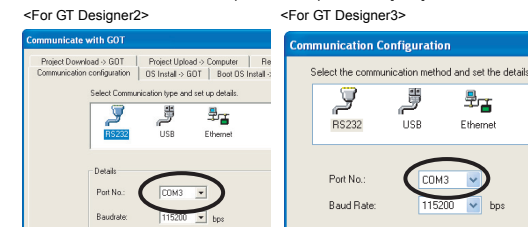

7.2.2 Setting GX Developer

- 1) Click [Online] → [Transfer Setup].
- 2) Double-click [Serial] → [PC side I/F].
Check [RS-232].
Select the same COM number as the COM number of the personal computer when the setting COM number screen appears.
Click [OK].

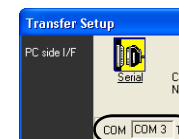

8. Troubleshooting

If communication cannot be established between the GOT and a PC using conversion adaptor, confirm the following status by checking display LED in conversion adaptor.

State of POWER LED	Contents
POWER LED is lit.	The DC5V power supply from the personal computer is normally supplied. In case of no communication, check the status of SD LED and RD LED.
POWER LED is not lit.	The DC5V power supply from the personal computer is not supplied. Check the items below. • Confirm that the specified cable is used to connect the personal computer. • Check that the OS is running on the PC.

The status of SD LED and RD LED.	Contents
Blinking	Communicating correctly
SD Extinguished	• Confirm the personal computer and the GOT are connected properly with the specified cable. • Check that the software settings on the PC are correct. Refer to the Section7.2 Setting software. For details on software setting procedures, refer to the respective software manual.
Blinking	Data receiving
RD Extinguished	• Confirm that the power is supplied to GOT. • Confirm the personal computer and the GOT are connected properly with the specified cable. • Check that the software settings on the PC are correct. Refer to the Section7.2 Setting software. For details on software setting procedures, refer to the respective software manual.

* When driver installation is required after already establishing USB communication.
→ This product requires USB Driver Installation for each USB port to be connected. Connect the product to a driver-installed USB port, or install the driver to the current port.

This manual confers no industrial property rights or any rights of any other kind, nor does it confer any patent licenses. Mitsubishi Electric Corporation cannot be held responsible for any problems involving industrial property rights which may occur as a result of using the contents noted in this manual.

Warranty

Mitsubishi will not be held liable for damage caused by factors found not to be the cause of Mitsubishi; opportunity loss or lost profits caused by faults in the Mitsubishi products; damage, secondary damage, accident compensation caused by special factors unpredictable by Mitsubishi; damages to products other than Mitsubishi products; and to other duties.

⚠ For safe use

- This product has been manufactured as a general-purpose part for general industries, and has not been designed or manufactured to be incorporated in a device or system used in purposes related to human life.
- Before using the product for special purposes such as nuclear power, electric power, aerospace, medicine or passenger movement vehicles, consult with Mitsubishi Electric.
- This product has been manufactured under strict quality control. However when installing the product where major accidents or losses could occur if the product fails, install appropriate backup or failsafe functions in the system.

MITSUBISHI ELECTRIC CORPORATION

HEAD OFFICE : TOKYO BUILDING, 2-7-3 MARUNOUCHI, CHIYODA-KU, TOKYO 100-8310, JAPAN
HIMEJI WORKS : 840, CHIYODA CHO, HIMEJI, JAPAN

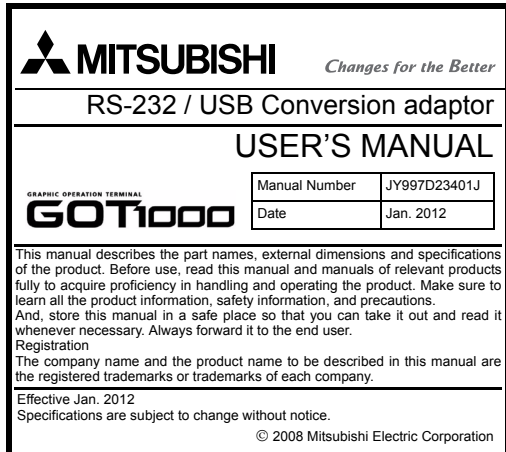

Safety Precaution (Read these precautions before using.)

This manual classifies the safety precautions into two categories:

⚠ DANGER and **⚠ CAUTION**.

⚠ DANGER	Indicates that incorrect handling may cause hazardous conditions, resulting in death or severe injury.
⚠ CAUTION	Indicates that incorrect handling may cause hazardous conditions, resulting in medium or slight personal injury or physical damage.

Depending on circumstances, procedures indicated by **⚠ CAUTION** may also be linked to serious results. In any case, it is important to follow the directions for usage.

CAUTION MOUNTING PRECAUTIONS

- Use the conversion adaptor in the environment that satisfies the general specifications described in GT10 User's Manual.
- Never use the product in areas with excessive dust, oily smoke, conductive dusts, corrosive gas (salt air, Cl₂, H₂S, SO₂ or NO₂), flammable gas, vibration or impacts, or exposed to high temperature, condensation, or rain and wind. Not doing so can cause an electric shock, fire, malfunction or product damage or deterioration.

CAUTION STARTUP/MAINTENANCE PRECAUTIONS

- Do not disassemble or modify the conversion adaptor. Doing so can cause a failure, malfunction, injury or fire.
- Do not touch the conductive and electronic parts of the conversion adaptor directly. Doing so can cause a unit malfunction or failure.
- When unplugging the conversion adaptor connected to the unit, do not hold and pull the cable portion. Doing so can cause the unit or cable to be damaged or can cause a malfunction due to a cable connection fault.

CAUTION DISPOSAL PRECAUTIONS

- When disposing of the product, handle it as industrial waste.

CAUTION TRANSPORTATION PRECAUTIONS

- Make sure to transport the conversion adaptor and/or relevant unit(s) in the manner they will not be exposed to the impact exceeding the impact resistance described in the general specifications of this manual, as they are precision devices. Failure to do so may cause the unit to fail. Check if the unit operates correctly after transportation.

Related Manuals

When using the conversion adaptor, prepare the following manual as well. As GT10 User's Manual, GT Designer2 Version2 Basic Operation/Data Transfer Manual and GT Designer3 Version1 Screen Design Manual are sold separately, inquire at our local distributor for it. For details of a PLC to be connected, refer to the PLC user's manual respectively.

Manual name	Manual Number (Model Code)	Contents
GT10 User's Manual	JY997D24701 (09R819)	Describes the GT10 hardware-relevant content such as part names, external dimensions, mounting, wiring, specifications, and introduction to option devices.
GT Designer2 Version2 Basic Operation/Data Transfer Manual	SH-080529ENG (1D7M24)	Describes methods of the GT Designer2 installation operation, basic operation for drawing and transmitting data to GOT1000 series.
GT Designer3 Version1 Screen Design Manual (Fundamentals)	SH-080866ENG (1D7M89)	Describes methods of the GT Designer3 installation operation, basic operation for drawing and transmitting data to GOT1000 series.

ⓘ: Indispensable manual

For the manuals relevant to GOT1000, refer to the PDF manuals stored in the screen creation software used. For details about a PLC to be connected, refer to the manuals of PLCs respectively. For the FA transparent functionality, refer to the GOT1000 Series Connection Manual.

Bundled Items

Product	GT10-R2TUSB-5S RS-232/USB conversion adaptor
Included items	USB driver software (CD-ROM) ^{*1} RS-232/USB Conversion adaptor USER'S MANUAL (this manual)

^{*1} Download of USB driver software is possible from the following home page. MELFANSweb home page: <http://www2.mitsubishielectric.co.jp/melfansweb/english/index.html>

1. Overview

The conversion adaptor convert the GOT's RS-232 interface to USB, thereby enabling the transparent functionality to transfer and monitor the sequence program, and the project data transfer between the GT10 main unit and the PC. Use this conversion adaptor with the GT09-C30USB-5P type USB cable.

2. Part Names and External Dimensions

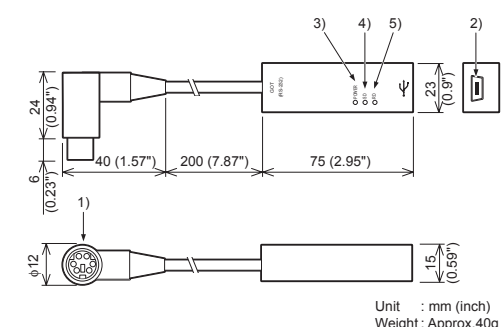

No.	Name	Specifications
1)	RS-232 Connector	MINI-DIN 6 Pins (male): For connecting GOT
2)	USB Connector	Mini-B: For connecting USB cable
3)	Display LED (POWER)	Green: Lit when the power is properly supplied (Lit when connected to the PC with a USB cable)
4)	Display LED (SD)	Red: Lit while sending data (GOT → PC)
5)	Display LED (RD)	Red: Lit while receiving data (PC → GOT)

3. Specifications

3.1 Operating atmosphere

Must be free of lamp black, corrosive gas, flammable gas, or excessive amount of electro conductive dust particles and must be no direct sunlight. (Same as for saving)

3.2 General Specifications

General specifications are the same as the GT10 main unit. For general specifications, refer to the GT10 user's manual.

3.3 Performance Specifications

Level Conversion	Bidirectional between RS-232 and USB	
Communication Type	GOT	RS-232
PC		USB2.0 (For full speed)
Transmission speed	115,200/ 57,600/ 38,400/ 19,200/ 9,600/ 4,800 bps	
Supply voltage	RS-232 side	DC5V ± 5% (from GOT)
USB side	DC5V ± 5% (from PC)	
Power consumption	RS-232 side	200mW (40mA/DC5V)
USB side	275mW (55mA/DC5V)	

3.4 System Requirements (Communication driver)

OS	Microsoft® Windows®98, Windows®98SE Microsoft® Windows®Millennium Edition (Windows® Me) Microsoft® Windows®2000, Microsoft® Windows®XP Microsoft® Windows Vista®, Microsoft® Windows®7
Software	GT Designer2, GT Designer3, GX Developer, GX Works2 Refer to the following for other available software: GOT1000 Series Connection Manual (FA transparent function)

3.5 USB cable (sold separately)

Product name	Model name	
USB cable	GT09-C30USB-5P (3m)	Mitsubishi Electric System Service Co, LTD

4. System Configuration

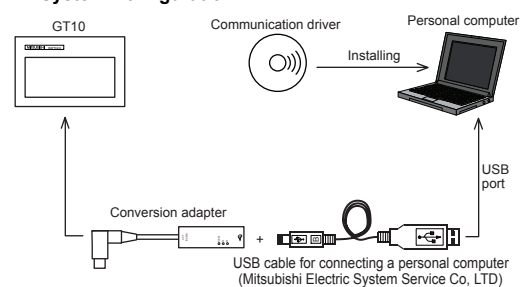

5. Connecting Procedure

- Turn the GOT power off.
- Connect the RS-232 connector of the conversion adaptor to the GOT.
- Connect the USB MINI-B connector of the USB cable to the conversion adaptor.
- Connect the USB A connector of the USB cable to the personal computer.
- Turn the GOT power on.
- Make sure the display LED (POWER) lamp of the conversion adaptor is lit. (The display LED (POWER) lamp of conversion adaptor lights when power is supplied normally by the personal computer.)

6. Driver Installation

Note: If installation of the driver software is cancelled in the middle, the driver software is not installed normally. Install the driver software again. This product requires installation of the driver software for each connected USB port. When connecting this product to multiple USB ports, install the driver software for each USB port.

6.2 Windows Vista®

Please install the driver with the following procedure. Insert the CD-ROM offered as an accessory in step 3). Do not insert it earlier.

- When the USB cable is connected to the personal computer, the following screen is displayed. (Installation of the software for USB driver)

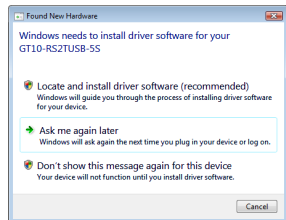

- Click [Locate and install software (recommended)].
- The search method confirmation screen is displayed. Click [Don't search online].
- When the message [Insert the disc that came with your GT10-RS2USB-5S] is displayed, insert the CD-ROM into the personal computer. Inserting the CD-ROM starts installation. When specifying the search location manually, specify the CD-ROM drive [Win2K].
- The following warning message is displayed.

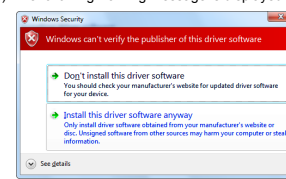

- Click [Install this driver software anyway].
- Installation of the driver software is started.
- When installation of the USB driver software is finished, the COM port driver software is installed continuously. The following screen is displayed.

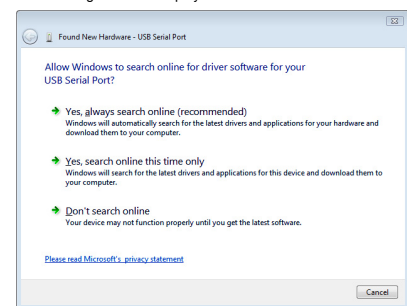

- Click [Don't search online].
- When the message [Insert the disc that came with your USB Serial port] is displayed, insert the CD-ROM into the personal computer. Inserting the CD-ROM starts installation. When specifying the search location manually, specify the CD-ROM drive [Win2K].
- The following warning message is displayed.

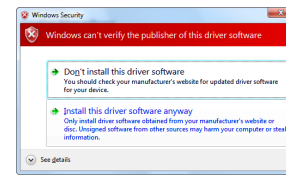

- Click [Install this driver software anyway].
- Installation of the driver software is started.
- When installation is finished, remove the CD-ROM.
- Now, installation of the USB driver software is finished.

6.3 Windows® 7 (32bits, 64bits)

Please install the driver with the following procedure. Insert the CD-ROM offered as an accessory in step 4). Do not insert it earlier.

- Connect the USB cable to the personal computer.
- In the case of 32 bits, click [Control Panel] → [Hardware and Sound] → [Devices and Printers] to display the following screen.
- When the driver software search method selection screen is displayed, select [Browse my computer for driver software].
- Insert the CD-ROM into the personal computer.
- The search location specification screen is displayed. Specify the CD-ROM drive [Win2K] as the search location, and click [Next]. Installation is started.
- The following warning message is displayed.

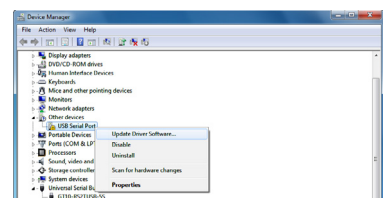

Right-click the GT10-RS2TUSB-5S, and select [Update Driver Software]. In the case of 64 bits, click [Control Panel] → [Hardware and Sound] → [Devices and Printers] to display the screen. Right-click "GT10-RS2TUSB-5S", and select [Properties] → [Hardware] tab → [Properties] → [Change settings] → [Update Driver].

When the driver software search method selection screen is displayed, select [Browse my computer for driver software].

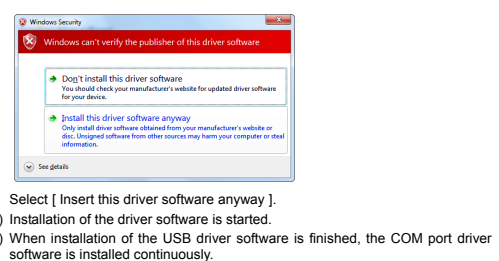

- Select [Insert this driver software anyway].
- Installation of the driver software is started.
- When installation of the USB driver software is finished, the COM port driver software is installed continuously.

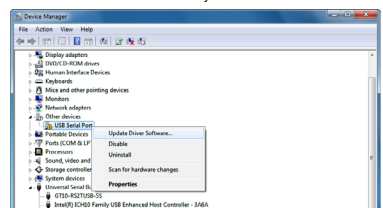

In the case of 32 bits, right-click [USB Serial Port] in the Device Manager. Select [Update Driver Software]. In the case of 64 bits, right-click "GT10-RS2TUSB-5S" in the Devices and Printers, and select [Properties] → [Hardware] tab → [USB Serial Port] → [Properties] → [Change settings] → [Update Driver].

- When the driver software search method selection screen is displayed, select [Browse my computer for driver software].
- The search location specification screen is displayed. Specify the CD-ROM drive [Win2K] as the search location, and click [Next]. Installation is started.
- The following warning message is displayed.
- Select [Install this driver software anyway].
- Installation of the driver software is started.
- When installation is finished, remove the CD-ROM.
- Now, installation of the USB driver software is finished.

7. Installation Confirmation of Driver, Setting Software

7.1 Installation Confirmation of Driver

Procedure for confirming the installation of the driver is described below. Windows® XP example follows.

- In Windows® XP, click [Start] → [Settings] → [Control Panel] → [Performance and Maintenance] → [System] → [Hardware] → [Device Manager (D)] and the window below will be displayed. Please confirm the COM number to which the USB driver is allocated (COM and LPT).
- If using Windows® 98, Windows® 98SE, Windows® Millennium Edition or Windows® 2000. A screen that is equivalent to the one below is displayed by clicking [My Computer] → [Control Panel] → [System] → [Device Manager] in the menu of the personal computer.
- In Windows Vista®, click [Start] → [Control Panel] → [Hardware and Sound] → [Device Manager] and the window below will be displayed.
- In Windows® 7, click [Control Panel] → [Hardware and Sound] → [Device Manager] and the window below will be displayed.

When the user account control is valid

Only when the user account control is valid, the [user account control] screen is displayed. If this screen is displayed, click [Continue].

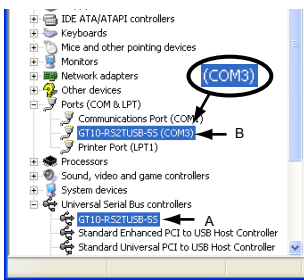

- Check following:
- GT10-RS2TUSB-5S is indicated at A).
 - GT10-RS2TUSB-5S (COM *) is indicated at B).
 - * indicates the COM number used in Conversion adaptor.
 - Install the driver again when is displayed.

Select the programming software COM number as the COM number currently assigned on the screen above.

7.2 Setting Software

7.2.1 Setting drawing software

In GT Designer2, click [Communication] → [To/From GOT...] → [Communication configuration] tab → [RS232].

In GT Designer3, click [Communication] → [Communication Configuration...] → [RS232].

When the communication port selection screen is displayed, select the same COM number as the COM number of the personal computer. Click [OK].

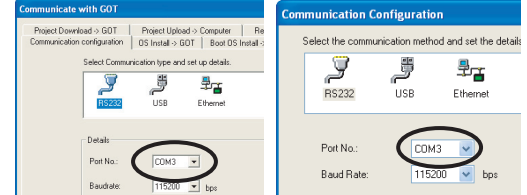

7.2.2 Setting GX Developer

- Click [Online] → [Transfer Setup].
- Double-click [Serial] of PC side I/F. Check [RS-232]. Select the same COM number as the COM number of the personal computer when the setting COM number screen appears. Click [OK].

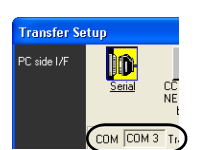

Folder structure of USB driver software

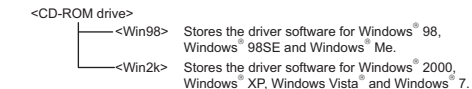

6.1 Windows® 98, Windows® 98SE, Windows® Me, Windows® 2000, and Windows® XP

Please install the driver with the following procedure. 1) When the USB cable is connected to the personal computer, the following screen is displayed. (Installation of the software for USB driver)



- Click [Continue Anyway].
- The wizard finish screen is displayed. Click [Finish]. If using Windows® 2000 or Windows® XP, proceed to step 4).
- If Windows® 98, Windows® 98SE or Windows® Me is used, installation of the USB Serial Port software begins, and ends automatically. The CD-ROM can be removed from the personal computer at this time. The installation of the USB driver software is finished.
- The following screen is displayed. (Only in Windows® XP)



- Click [Continue Anyway].
- The wizard finish screen is displayed. Click [Finish]. If using Windows® 2000 or Windows® XP, proceed to step 4).
- If Windows® 98, Windows® 98SE or Windows® Me is used, installation of the USB Serial Port software begins, and ends automatically. The CD-ROM can be removed from the personal computer at this time. The installation of the USB driver software is finished.
- The following screen is displayed.

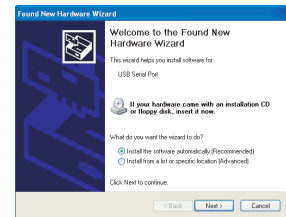

- Click [Next >]. The installation of the USB Serial Port software will begin.
- In Windows® 2000, click [Include this location in the search], specify the CD-ROM drive [Win2K], and then install the driver software.
- The screen of 2) is displayed. (Only in Windows® XP) Click [Continue Anyway].
- The wizard finish screen is displayed. The following screen is displayed. Click [Finish]. The installation of the USB Serial Port software will finish. The CD-ROM (USB driver software) can be removed from the personal computer at this time.

8. Troubleshooting

If communication cannot be established between the GOT and a PC using conversion adaptor, confirm the following status by checking display LED in conversion adaptor.

State of POWER LED	Contents
POWER LED is lit.	The DC5V power supply from the personal computer is normally supplied. In case of no communication, check the status of SD LED and RD LED.
POWER LED is not lit.	The DC5V power supply from the personal computer is not supplied. Check the items below. <ul style="list-style-type: none"> Confirm that the specified cable is used to connect the personal computer. Check that the OS is running on the PC.

The status of SD LED and RD LED.	Contents
Blinking	Communicating correctly
SD Extinguished	<ul style="list-style-type: none"> Confirm the personal computer and the GOT are connected properly with the specified cable. Check that the software settings on the PC are correct. Refer to the Section7.2 Setting software. For details on software setting procedures, refer to the respective software manual.
Blinking	Data receiving
RD Extinguished	<ul style="list-style-type: none"> Confirm that the power is supplied to GOT. Confirm the personal computer and the GOT are connected properly with the specified cable. Check that the software settings on the PC are correct. Refer to the Section7.2 Setting software. For details on software setting procedures, refer to the respective software manual.

* When driver installation is required after already establishing USB communication. → This product requires USB Driver Installation for each USB port to be connected. Connect the product to a driver-installed USB port, or install the driver to the current port.

This manual confers no industrial property rights or any rights of any other kind, nor does it confer any patent licenses. Mitsubishi Electric Corporation cannot be held responsible for any problems involving industrial property rights which may occur as a result of using the contents noted in this manual.

Warranty
Mitsubishi will not be held liable for damage caused by factors found not to be the cause of Mitsubishi; opportunity loss or lost profits caused by faults in the Mitsubishi products; damage, secondary damage, accident compensation caused by special factors unpredictable by Mitsubishi; damages to products other than Mitsubishi products; and to other duties.

⚠ For safe use

- This product has been manufactured as a general-purpose part for general industries, and has not been designed or manufactured to be incorporated in a device or system used in purposes related to human life.
- Before using the product for special purposes such as nuclear power, electric power, aerospace, medicine or passenger movement vehicles, consult with Mitsubishi Electric.
- This product has been manufactured under strict quality control. However when installing the product where major accidents or losses could occur if the product fails, install appropriate backup or failsafe functions in the system.